



# Multi-functional Flow Control Valve for Water Treatment Systems

- TM.F67B1/ F67B2
- TM.F71B1/ F71B2
- TM.F75A1/ F75A2

## User manual

Please read this manual in details  
before using this valve and keep it properly  
in order to consult in the future





# Content

Preface	1
Product characteristics	2
Appearance and Specification of the Product	3
●Product Appearance	3
●Product Accessories	4
●Product Specification	4
Installation and Connection	5
Controller Operation Instruction	8
●Control Panel	8
Establishment of Each Parameter	10
Settlement Forms of Parameter	11
Trial Running	11
Working Principle and Flow Chart	12
Maintenance Guide	13
Guarantee Card	14

## Preface

Dear user. Thank you for using RUNXIN brand multi-functional flow control valve for water treatment systems. Please read this manual carefully before using, which will contribute to your machine offering perfect services for you normally for a long time.

RUNXIN brand multi-functional flow control valve is our patent product (Patent Number: ZL02257746.7, ZL02220153.X ) which specially allocate in all kinds of water treatment systems. It adopts microcomputer to control, and also can establish every parameter according to the using situation to realize purification and cleaning filter materials automatically. This control valve has high hardness and pottery of degree of high level ceramic moving slice inside its body. As relative and moving slice have different blind holes and put through holes respectively, with change of the relative angle during slice rotate one course of circle definitely with it height laminating, it produces three different fluid pass way so as to realize these necessary functions, namely Service, Backwash and Fast Rinse. As the core control part for water treatment systems, this valve changes traditional water treatment systems tedious operation mode of a lot of valves and many pieces of pipelines, integrating various kinds of functions in one which is easier to install and operate.





- To ensure normal operation of the valve, please consult with professional installation or repairing personnel before use it.
- If there are any of pipeline engineering and electric works, there must be finished by professional at the time of installation.
- Do not use the control valve with water that is unsafe or of unknown quality.
- Test water periodically to verify that system is performing satisfactorily.
- Do not put the valve near hot resources or high humidity environment. And do not leave it outside.
- Forbidden to use drain tube or other connectors as support to carry system.
- Please use this product under the temperature between 5°C and 45°C, water pressure between 0.1MPa and 0.6MPa. Failure to use this product under such conditions voids the warranty.
- If the water pressure exceeds 0.6MPa, a pressure reducing valve must be installed before the water inlet.
- Do not let children touch or play with the valve. Because of carelessness operating may cause the procedure changed.
- When the attached cables of this product and transformer are damaged, they must be changed to the one that is from our factory.

## Product Characteristics

- **More reliable way of opening and closing**

It adopts the seal slice with high degree pottery, scuff resistance, corrosion proof and leak proof.

- **Manual function**

Realizing washing immediately by pushing manual button at any time; Using the hand wheel to carry on manual operation when power off or controller unable to work normally (Suitable for F67 series).

- **Keyboard locked function**

If the keyboard has not been operated within one minute, it will be locked automatically. Press the ▲ and ▼ two buttons for 5 seconds to unlock the keyboard before operating. This function can avoid the wrong operation by confusion effectively.

- **It adopts LED dynamic colourful screen.**

The colourful screen welter continuously shows it is in service state, or else, it is in washing state.

- **Indication of power cut secularly.**

If the power has been cut exceeds 3 days, the clock figure  will flicker continuously after power on. It reminds to reset the current time. The other set parameters do not need to reset. The process will continue to work after power on.



- **Two modes of regeneration controlled.**

This valve has two modes: running by day and running by hour. By changing the locating position of switch on control panel in controller, it could realize exchange of the two status. It would be effective when you restart the valve. When the switch locates at ' ON ' position, it would run by day; while on ' 1 ' position, run by hour. ( detailed instruction please refer to page 6, picture 4)

- **Having output signal connector (Signal output operation should be done by professional personnel).**

This valve has the output signal connector which could be connected with the equipment such as Booster Pump, Solenoid Valve etc. The signal is sent at the moment while the valve leaves from the position of running, and disappeared while it arrives at the running state.

( The particular connect method please turn to page 7, picture 5 )

- **It could set up repeat-washing**

The valve could be set to perform washing repeatedly, ie service one time, backwash and fast rinse for several times (the times is up to you). This function devotes to better washing of filtering material. (Detailed connect ways please refer to page 7 )

- **By-pass (discharge raw water) function (only suitable for F67 series)**

Cut the power off, turn the wheel to make the indicator locate at ' ● ' position to realize such function. The raw water discharged directly from water outlet, not go through the tank and the filtering materials. Such function could be performed not only when maintaining the tank or exchanging the materials, but also when the quality of raw water is so good that it no need to filter.

## Appearance and Specification of the Product

### Product Appearance (Only for reference please subject to the real goods)

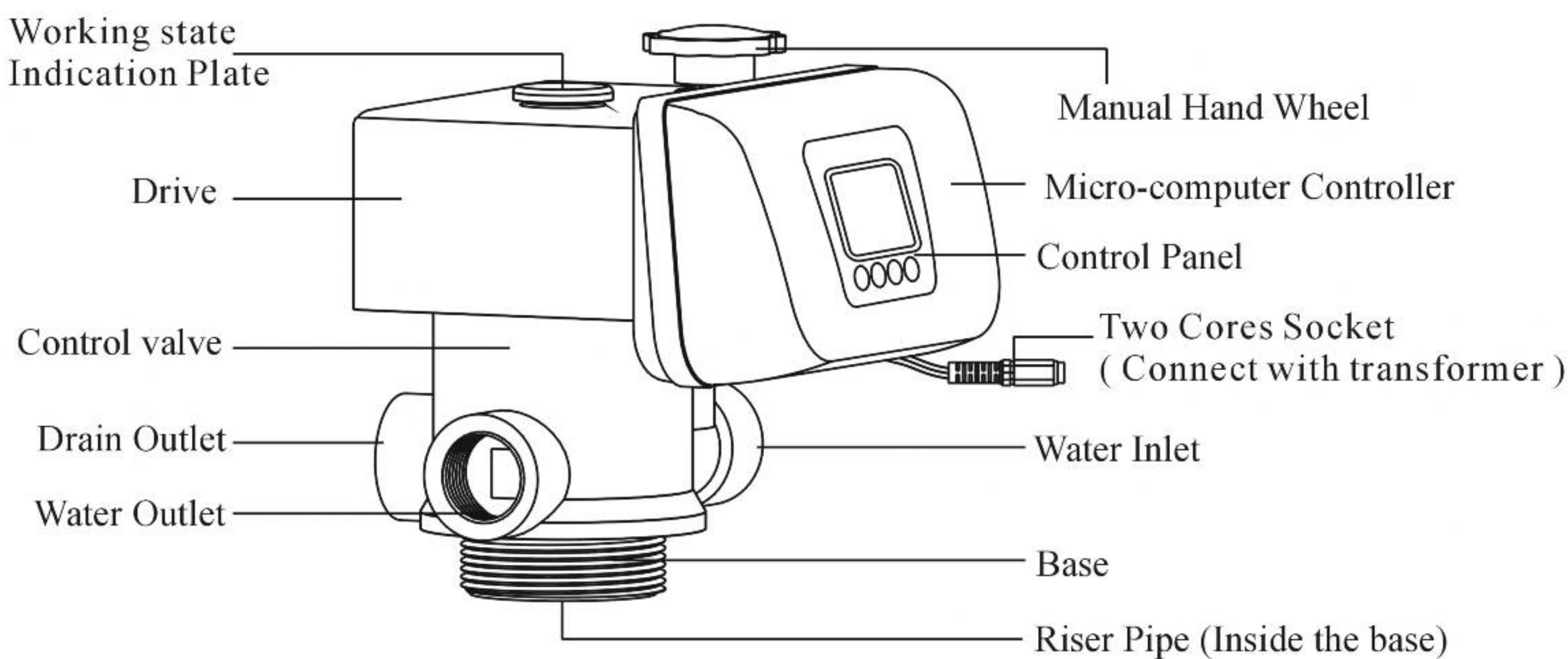

**TM.F67B**



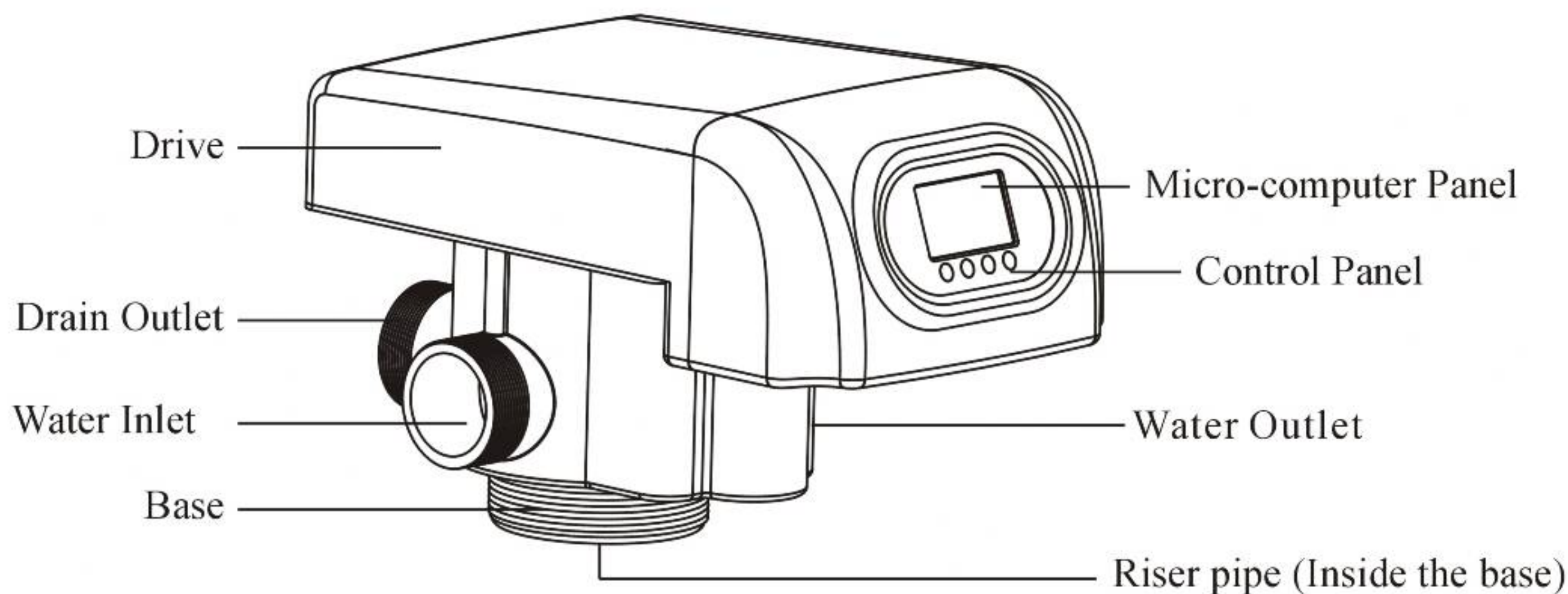
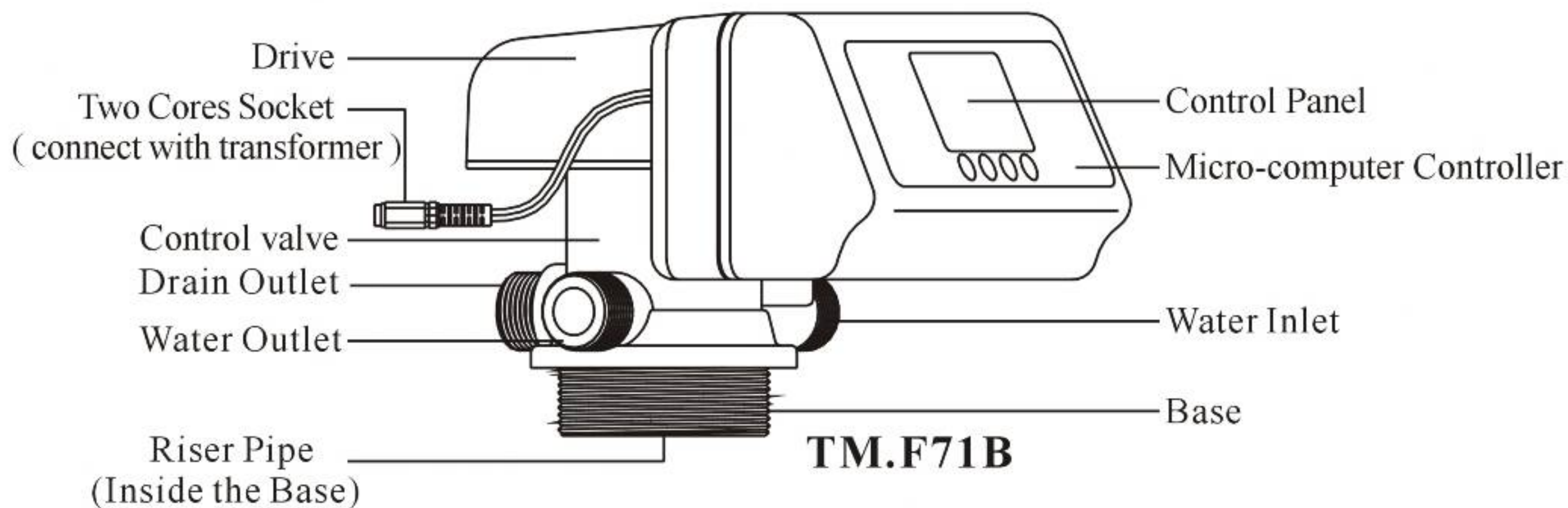

**Product Accessories**

**TM.F75A**

TM.F67B		TM.F71B		TM.F75A	
Description	QTY	Description	QTY	Description	QTY
Transformer (EU plug, US plug or UK plug)	1PC	Transformer (EU plug, US plug or UK plug)	1PC	Transformer (EU plug, US plug or UK plug)	1PC
Base O-ring ( $\phi 73 \times \phi 5.3$ )	1PC	Base O-ring ( $\phi 73 \times \phi 5.3$ )	1PC	Base O-ring ( $\phi 104.6 \times \phi 5.7$ )	1PC
1" Washer ( $\phi 30 \times \phi 24 \times 3.3$ )	3PCS	3/4" Washer ( $\phi 24 \times \phi 18 \times 3$ )	3PCS	/	/

**Product specification**

Controller mode---- Time Type

Working Condition: Suited Pressure----0.1~0.6MPa

Transformer Input----100~240V/50~60Hz

Suited Temperature----5~45°C

( Table 1 )

**Control valve**

Model	Connection sizes				Running mode	Maximum water capacity m <sup>3</sup> /h	Wheel
	Inlet/outlet	Drain outlet	Base	Riser pipe			
TM.F67B1	1" F	1" F	2-1/2" -8NPSM	1.05" OD(26.7mm)	Day	6	✓
TM.F67B2	1" F	1" F	2-1/2" -8NPSM	1.05" OD(26.7mm)	Hour	6	✓
TM.F71B1	3/4" M	3/4" M	2-1/2" -8NPSM	1.05" OD(26.7mm)	Day	2	/
TM.F71B2	3/4" M	3/4" M	2-1/2" -8NPSM	1.05" OD(26.7mm)	Hour	2	/
TM.F75A1	2" M	2" M	4" -8UN	1.5" D-GB(50mm)	Day	10	/
TM.F75A2	2" M	2" M	4" -8UN	1.5" D-GB(50mm)	Hour	10	/

Note: M --- Male Thread F --- Female Thread OD --- Outside Diameter



# Installation and Connection

Before installation, read all those instructions completely. Then obtain all the materials and tools needed for installation.

Perform installation according to regulated Water Inlet, Water Outlet, Drain Outlet, Brine Line Connector and relative plumbing codes.

## 1、 Device Location:

- ① The closer filter to drain point, the better.
- ② Leave a certain space for operating and maintaining devices conveniently.
- ③ Do not install the valve near hot resources or in direct sunlight, rain and other factors that may result in damage to the product. And do not leave it outside.
- ④ Do not install the equipment in an acid or alkali environment or more magnetic field, more vibrations to avoid damaging the electronically control system.
- ⑤ Do not install the device, drain outlet and other pipes under environment where the temperature may drop below 5°C or above 45°C.
- ⑥ Please install the system in a place where water damage is least likely to occur if a leak develops.

## 2、 Pipeline Connection

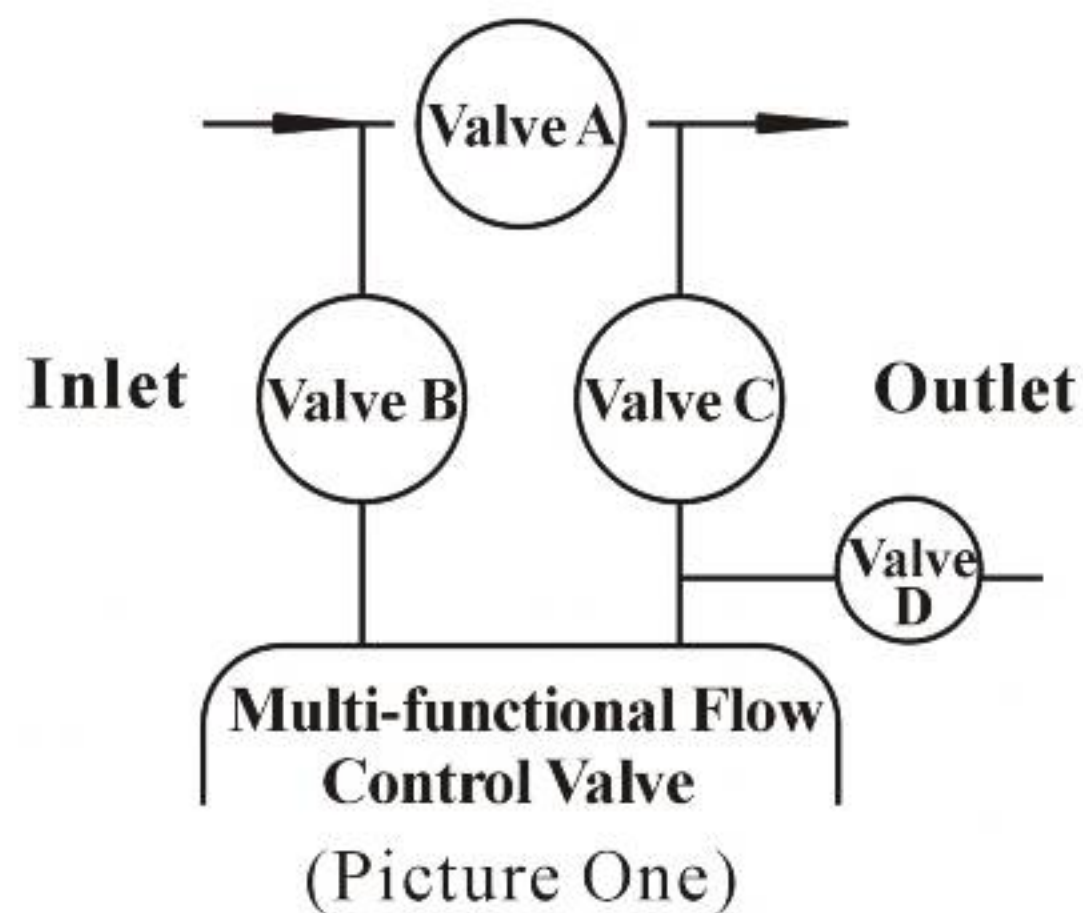

In order to maintain conveniently, device is advised installation like drawing as follows:

Instruction: There are three ball valves being connected to the multi-functional flow control valve and inlet outlet pipe. Valve B is connected to the inlet pipe. Valve C is connected to the outlet pipe. When changing filter materials or maintaining tank, open valve A, close valve B, C. When using, open valve B, C, close valve A. Valve D is for taking water to test.



- If making a soldered copper installation, do all sweat soldering before connecting pipes to the valve. Torch heat will damage plastic parts.
- When turning threaded pipe fittings onto plastic fitting, use care not to cross thread.
- Support inlet and outlet plumbing in some manner (use pipe hanger) to keep the weight off of the valve fittings.

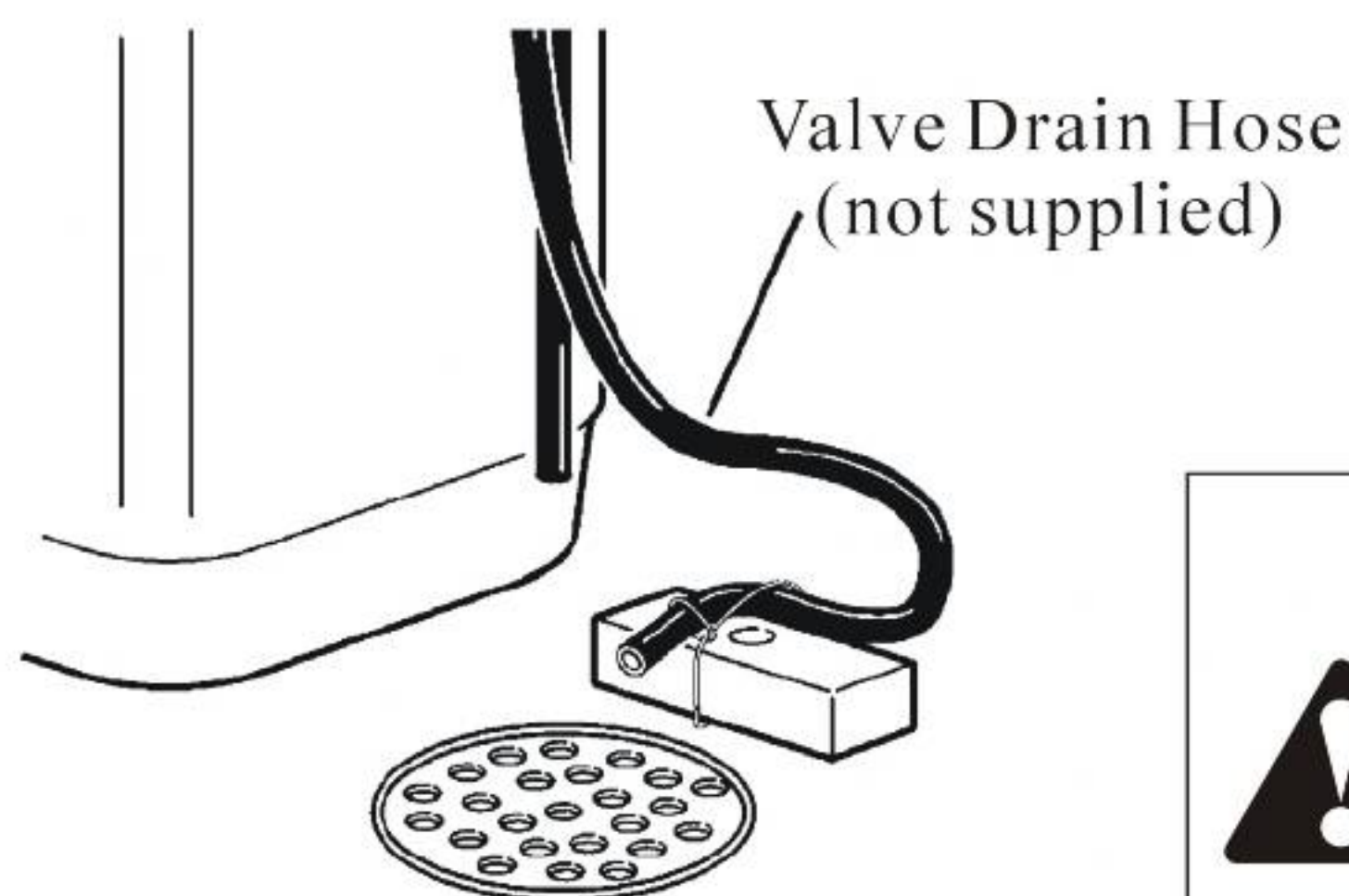

(Picture Two)  
Correct Method for Drain

## 3、 Connect and route the valve drain hose

Control valve should be higher than drain outlet, and be better not far from the drain hose.



Be sure not connect drain with sewer definitely, and leave a certain space between them avoiding wastewater be absorbing to the water treatment equipment, such as showed in picture two. If wastewater is used for other purpose, please use another container for loading. And also keep a certain space between drain and container.

## 4. Electronic Appliance Connection

- ① Put the adapter of the transformer output with two cores socket of controller .
- ② Put the adapter of transformer with the socket of 100~240V/50-60HZ directly.



## 5. Exchanging of operating by day or by hour

Depending on different situation, client could chose the mode of operating by day or by hour.

The adjust method as follows:

- ① Using the screwdriver or other tools to open the cover of control valve.
- ② There is a switch allocated in the main control panel as follow picture three(look at the follow megascopic picture four ).
- ③ When the switch allocates at 'ON' state, stand for the system in the state of service by day. When the switch allocates at '1' state, stand for the system in the state of service by hours. The client can exchange it as his need.
- ④ Install back the cover of control valve after adjusting. Remember it would be effective only after valve restarted.

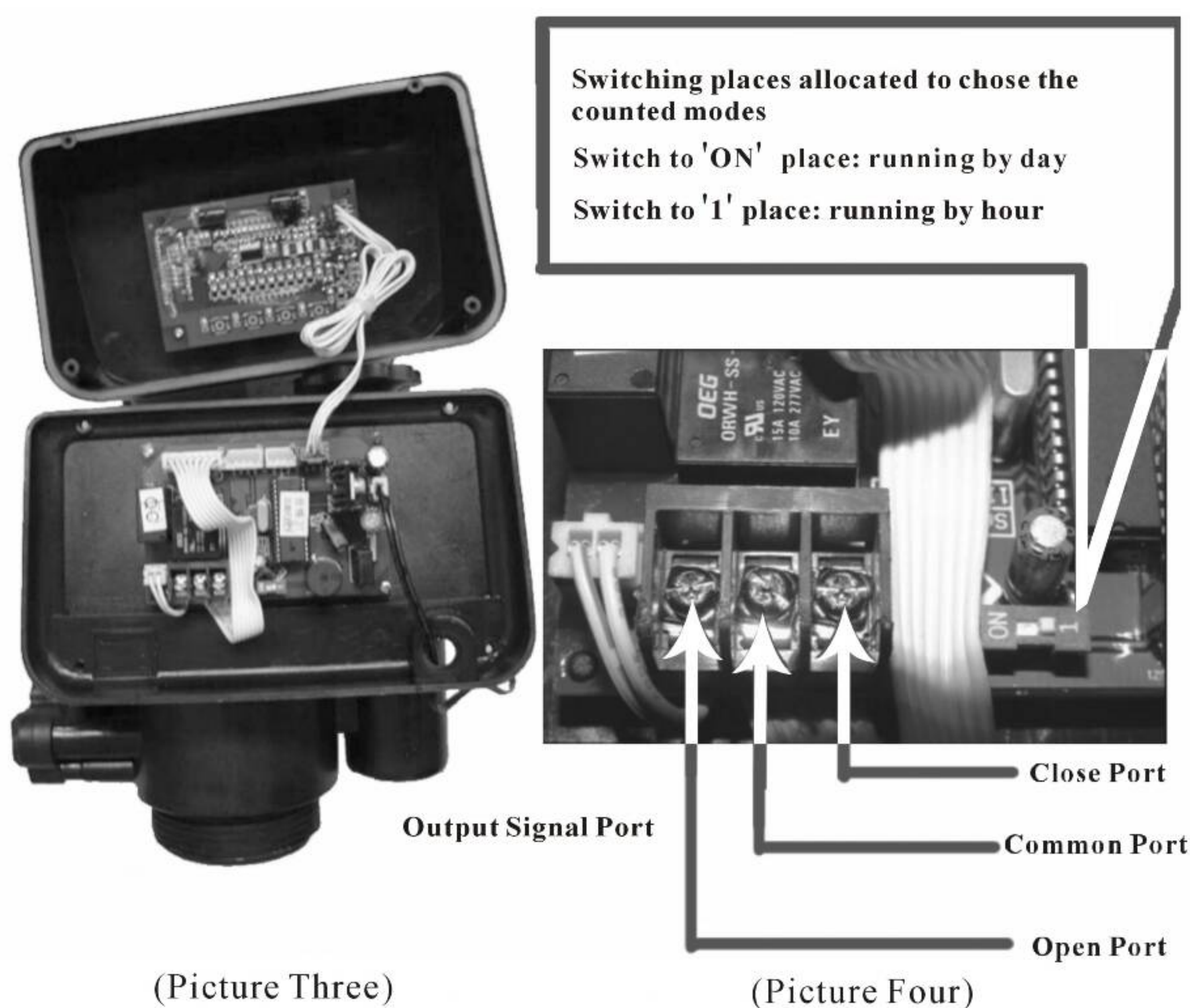

- When product ordered have no special requirement, the product will be set in our factory: The model of F63/F65/F68/F69 set by day, F74 set by hours.
- The different of two modes in the screen: the top right corner of screen show the letter 'D' when service by day, show the letter 'H' when service by hour.

## 6. Connect output signal.

Installing the equipment, the pressure of raw water is low or the outlet need flow forcible water, installing a booster pump at inlet and make use the output signal connector export the signal to control.

- ① Using the screwdriver or other tools to open the cover of control valve.
- ② At the output signal connector as follow picture four show, please connect wire as follow picture five show.



**Direct control booster valve connection mode (current<5A)**

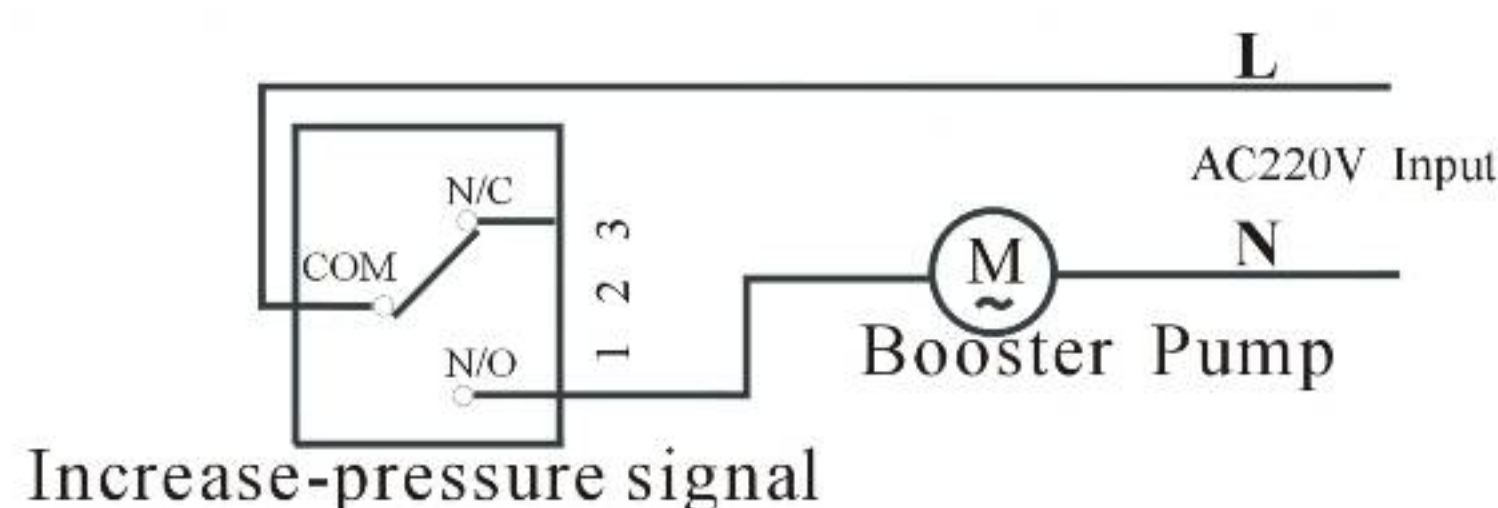

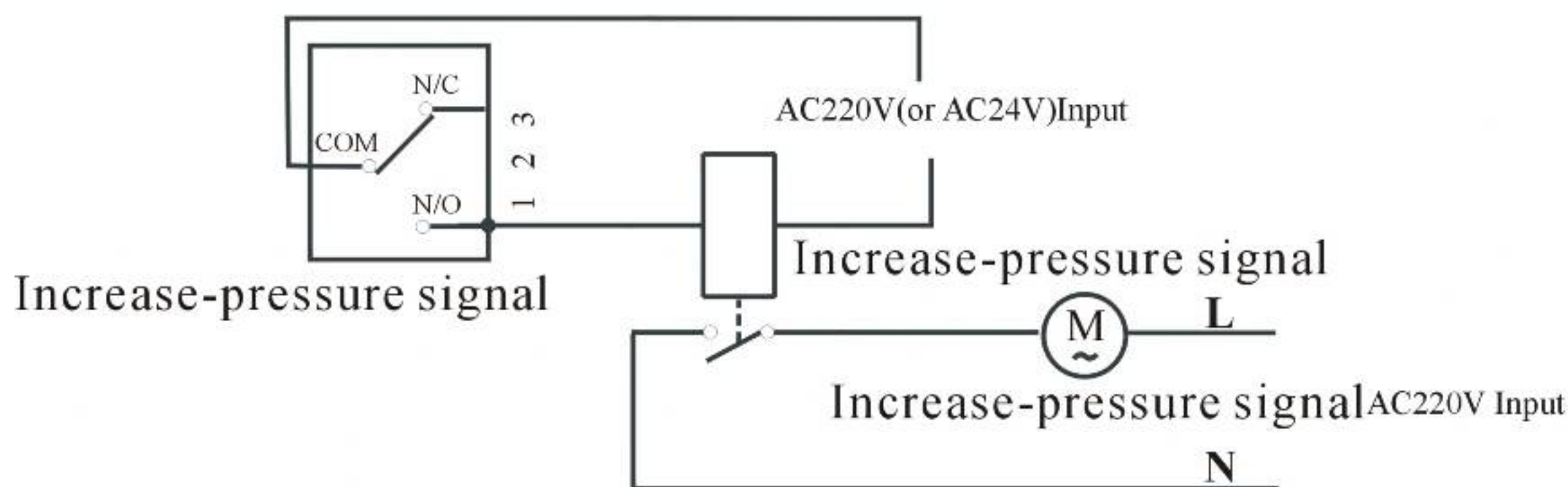

**AC Contactor (intermediate Relay) control Booster Valve connection mode (current>5A)**



**Request:AC220V electrical source input port need connect broken electrical leakage.**

( Picture Five )

	<ul style="list-style-type: none"> <li>● The time of signal for opening and closing: the signal open while the valve leaves f from the position of running, the signal close while the valve arrives at the running state.</li> <li>● AC220V power supply need to be connected with creepage breaker when connect the output signal wire.</li> <li>● Picture five shows the output signal connector. The common port at the middle station, marks N/C( right station) is close port, marks N/O (left station )is open port.</li> </ul>
---	--

	<ul style="list-style-type: none"> <li>● Failure to install the multi-functional flow control valve correctly voids the warranty.</li> <li>● If there are any of pipeline engineering and electric works, there must be finished by professional at the time of installation.</li> <li>● Minimum inlet water pressure is 0.1MPa, maximum inlet water pressure is 0.6MPa. If the inlet pressure exceeds 0.6MPa, a pressure reducing valve must be installed before inlet pipeline.</li> <li>● When installation, do not use drain tube or other connectors as support to carry.</li> <li>● Handle all components of this valve with care. Do not drop, drag or turn components upside down. And please use the accessories we supplied.</li> <li>● Forbidden over exerted when installation and connection pipelines to avoid thread broken. And no bearance of all stresses on all ports of the valve.</li> <li>● It is suggested to use PPR pipe, Wave-thread pipe or UPVC pipe, and avoid using Aluminum Plastic pipe.</li> <li>● The connection of all pipelines should be sealed enough, no leakage. Otherwise, flow capacity under some status may not reach expected effect.</li> </ul>
---	---

**7. Set of repeat-washing**

When the raw water is more turbidity, it could set up repeat washing times. If set F-01, it means service one time, backwash and fast rinse each of two times, viz. filter-backwash-fast rinse-backwash-fast rinse-filter.



# Controller Operation Instruction

## Control Panel

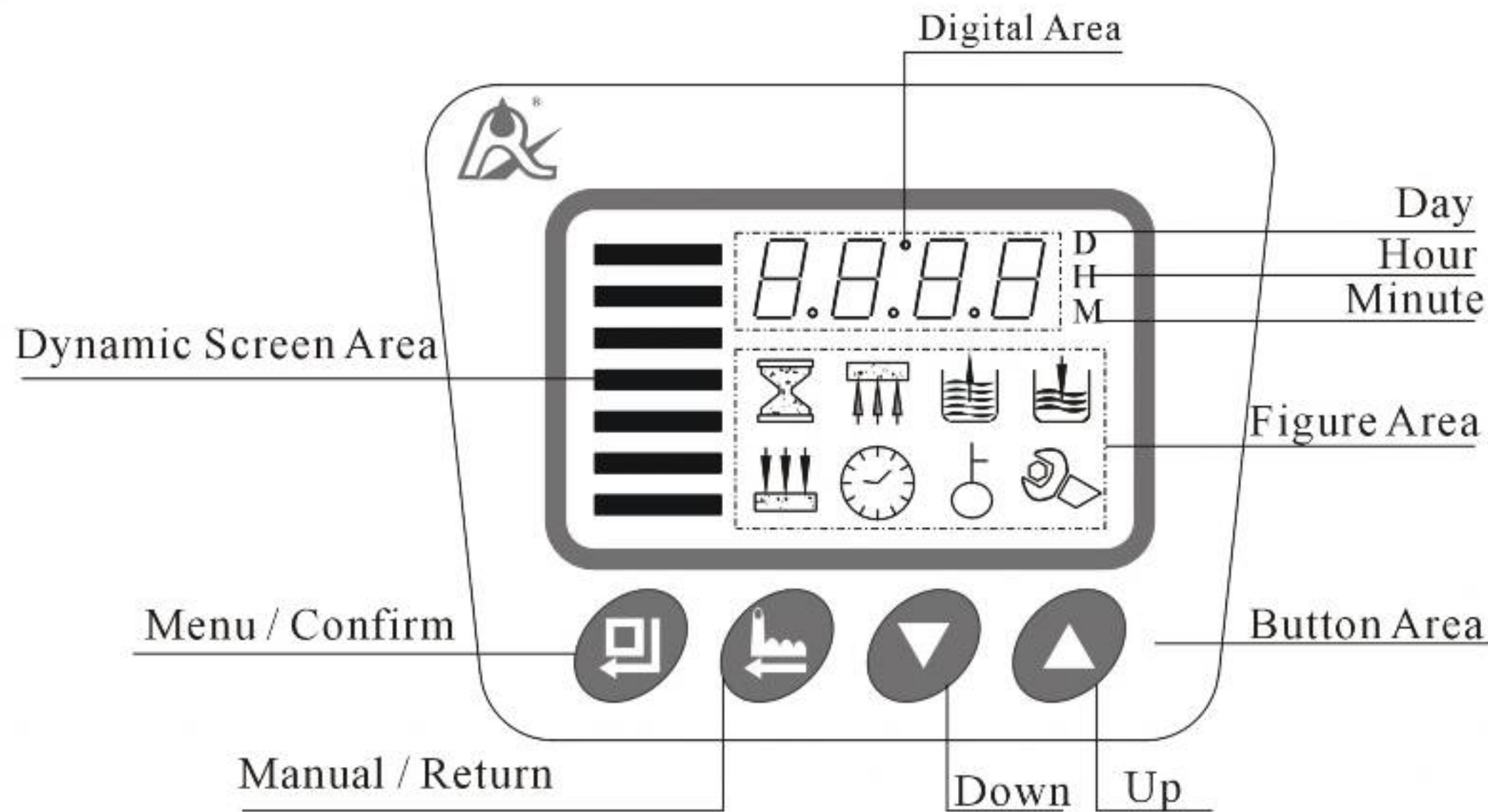

### 1. Show Screen

For day-counted control valves:F67B1/F71B1/F75A1,when at service state, the screen will show the following figures every 30 seconds circularly:

- ① Current service state (Digital symbol is matched with figure symbol); such as: 1-03<sup>D</sup>
- ② Current time; such as 12:20.
- ③ Washing start up time; such as 02: 00.

For example: For time control valves, when they are in service state, the screen will show following three pictures one by one.

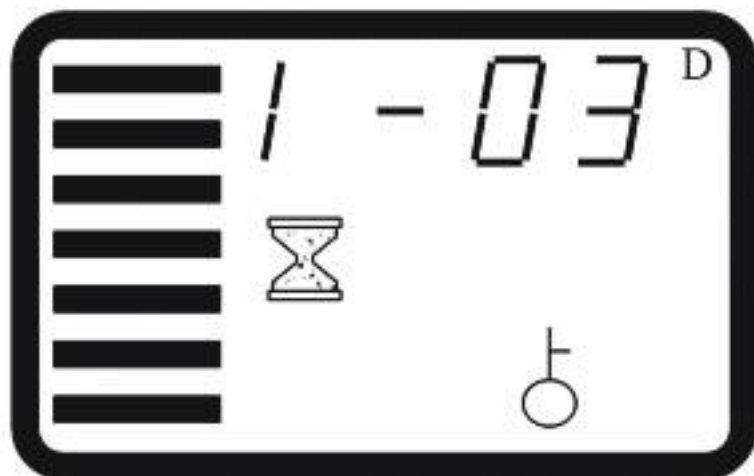

- ① Figure1、 icon ⌚ and dynamic showing of colourful strips indicate the valve is in service state. The above picture shows running time is 3 days left.



- ②Dynamic showing of colourful strips indicate the valve is in service state. The above picture ⌚ shows current time is 12: 20.



- ③ It shows washing start up time is 02: 00 am. (No such function if the valve washing by hour.)

For hour-counted control valves , F67B2/F71B2/F75A2, when they are at service state, the screen will show following contents every 30 seconds.



- ① current service state (digital symbols match with figure symbols),such as 1-18<sup>H</sup>.
- ② current time, such as 10:18.







- The colorful strips on the left of screen flicker dynamically show the system at the station of service.
- The colorful strips on the left of screen do not flicker show the system at the station of washing.
- The sign ⌚ light shows the system at the station of inquiring; the sign ⌚ flicker dynamically shows the system at the station of setting.
- When the figure ⌚ light, the keyboard is at the locked state .
- When the ⌚ flicking , indicate it has put out for a long time. Then should be reset.

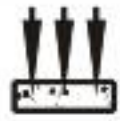



- For day-counted control valves, F67B1/F71B1/F75A1, its digital area and figure area and their meaning are as follows:

Show		Meanings	Note
Digital Area	Figure Area		
12:20		Current time is 12: 20	' : 'flash
02:00		Washing start-up time is 02: 00	' : 'unflash
F-00		Washing adding times	
1-03 <sup>D</sup>		At service state, left 3 days	
2-10 <sub>M</sub>		At backwash state, left 10 minutes	
3-08 <sub>M</sub>		At fast rinse state, left 8 minutes	

- For hour control valves, F67B2/F71B2/F75A2, its digital area and figure area and their meaning are as follows:

Show		Meanings	Note
Digital Area	Figure Area		
12:20		Current time is 12: 20	' : 'flash
F-00		Washing adding times	
1-20 <sub>H</sub>		At service state, left 20 hours	
2-10 <sub>M</sub>		At backwash state, left 10 minutes	
3-08 <sub>M</sub>		At fast rinse state, left 8 minutes	

## 2. Button

- Press this button to enter into menu, the setting sign  light , it could inquiry every parameter value.
- After entered into menu, press his button ,the showing numerical value and the setting sign  will flicker. Indicate it has entered into the setting state of this parameter.
- After set the parameter press this button, there is a sound 'DI' ,indicate it confirm setting and back to up step state.

## 3. Button

- Press this button when not in the menu state, it could finish the working state advance and go to the next working state immediately.
- Press this button when in the menu state and back to the up step menu.
- Press this button when in the setting state, the setting parameter has not preserved and back to the up step menu.

## 4. ▲ and ▼ button

- Enter into the menu, press ▲ or ▼ continuously it could show each parameter value press up or down.
- When setting the parameter ,Press ▲ or ▼ continuously it could adjust every parameter up or down
- Press ▲ and ▼ two buttons together for 5 seconds, it could unlock the locked keyboard.

















- Unlock the keyboard before set-up or look up the menu.
- Setting of F-00 should be done according to raw water's condition. When it is high turbidity, set is as F-01 or larger value. When it is low turbidity, it could be set as F-00.

## Establishment of Each Parameter

For example :The program is in the service state, if you want to set the current time 9:45 to 11:28, and the backwash time 10 minutes to 15 minutes, operate as the following steps:

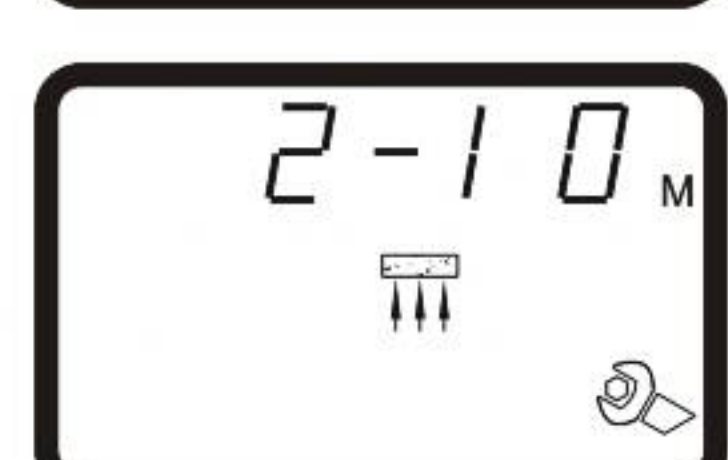
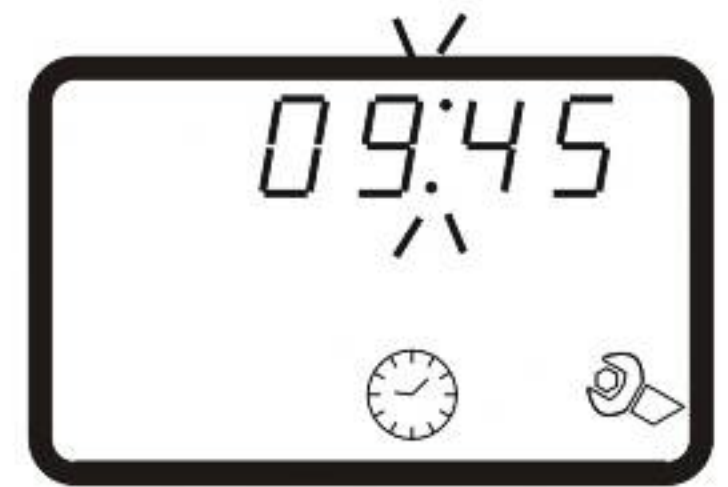

1. If the screen shows , indicate the keyboard is in the locked state, Press ▲ and ▼ two buttons together for 5 seconds, unlock the keyboard. If the screen don't show , indicate the keyboard has not locked, then enter into the second step directly.
2. Press  button to enter into menu, showing the current time of the first page of the menu, the setting sign  and the current time  light at meantime. Then, the sign ': ' flicker.
3. Press  button to enter into the setting state time value and the setting sign  start to flicker.
4. Press ▲ button continuously until the time value 09 change to 11.
5. Press  button, minute value and the setting sign flickering at meantime, then press ▼ button continuously until the minute value 45 to 28.
6. Press  button, there is a sound 'DI' the figure stop flickering, the program back to the inquiring state.
7. Press ▲ or ▼ button, until the backwash sign  light, as the right figure shows.
8. Press  button to enter into the setting state, numerical value 10 and the setting sign  start to flicker. Then press ▲ button continuously until the numerical value 10 change to 15.



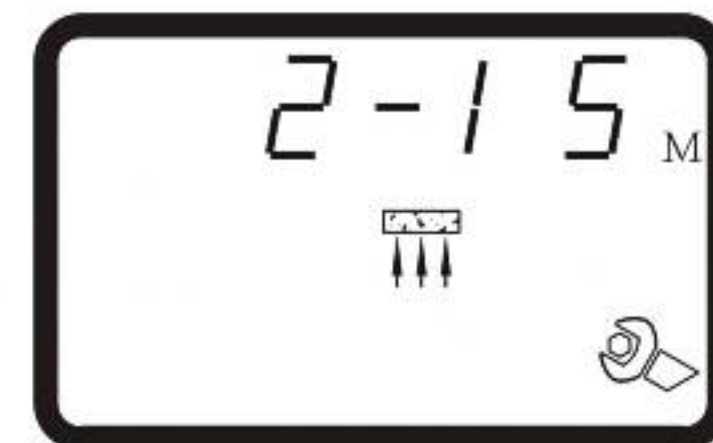

9. Press  button , there is a sound ' DI ',the figure stop flickering and the program back to the inquiring state.



10. Press  button back to menu ,the screen show the working state. If not operate keyboard in one minute , keyboard locked automatically, then the locked sign  light.

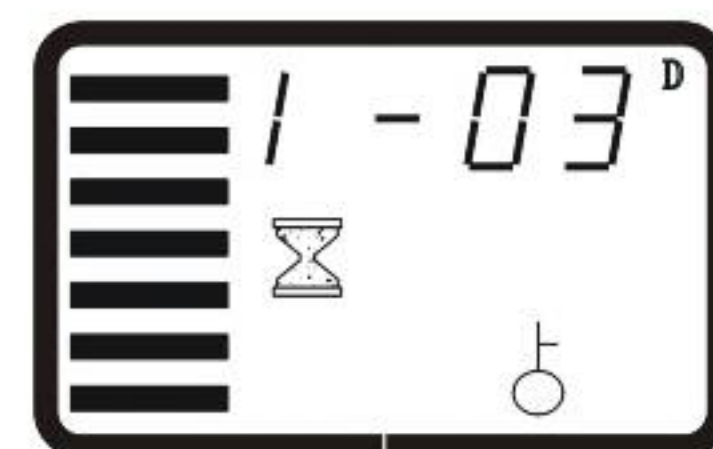

- For time control, running by day valve, its controller has the setting of ' washing start -uptime ' after the setting of current time, besides three operation positions and current time ect. There is no indication of ' washing start-up time ' in the show screen. The difference from current time is the ' : ' between hour and minute would unflash, while if it is current time, ' : ' would flash to remind you it is show current time. The setting of washing start -up time is same with that of current time.
- The time showed is based on twenty-four hours.



## Settlement Forms of Parameter

Contents	F67B1/F71B1/F75A1		F67B2/F71B2/F75A2		Min. Added Time Default of Factory
	Number Debug Range	Default of Factory	Number Debug Range	Default of Factory	
Current time	00:00 ~ 23:59	/	00:00 ~ 23:59	/	1
Washing start-up time	00:00 ~ 23:59	02:00	/	/	1
Washing adding times	0 ~ 20	0	0 ~ 20	0	1
Service time (day/hour)	0 ~ 99 day(s)	3 day(s)	0 ~ 99 hour(s)	20 hour(s)	1
Backwash time (minute)	0 ~ 99	10	0 ~ 99	10	1
Fast Rinse time (minute)	0 ~ 99	10	0 ~ 99	10	1

## Trial Running

1. Close the by-pass valve (valve A, as picture one, following same as); then connecting with the pipe and power.
2. Opening inlet valve B to 1/4 position slowly, making water flow into the tank. When water stop flowing, open the outlet valve C. Until all the air are out of the pipe, then close the outlet valve; and check whether it is leakage. In case it is, please solve it immediately.
3. After air is exhausted totally from the tank, open the inlet valve B completely.
4. Pressing  button to make it turn to backwash position, and let water discharges for 3~ 4 minutes.



5. Pressing  button to 'Fast Rinse' position, after Fast Rinse a certain time.
6. Taking out some water for analysis, after water quality is eligible press  bottom. Make control valve return to Service State; It could be used.
7. Setting up the time parameter according to operating instruction of controller.

	<ul style="list-style-type: none"> <li>● If the inlet water flow too quickly, material in resin tank will be damaged. The air sound from drain could be heard when water flow into tank slowly</li> <li>● When operate trial working ,F67series could be turned to needed position by hand wheel, after the power is cut off. Clockwise rotate the wheel according to the instructions on the indicator.</li> <li>● The setting of backwash, fast rinse and washing adding time could be made or refer to suggestions that set equipments suppliers offer you.</li> </ul>
---	---

## Working Principle and Flow Chart

### Service Position

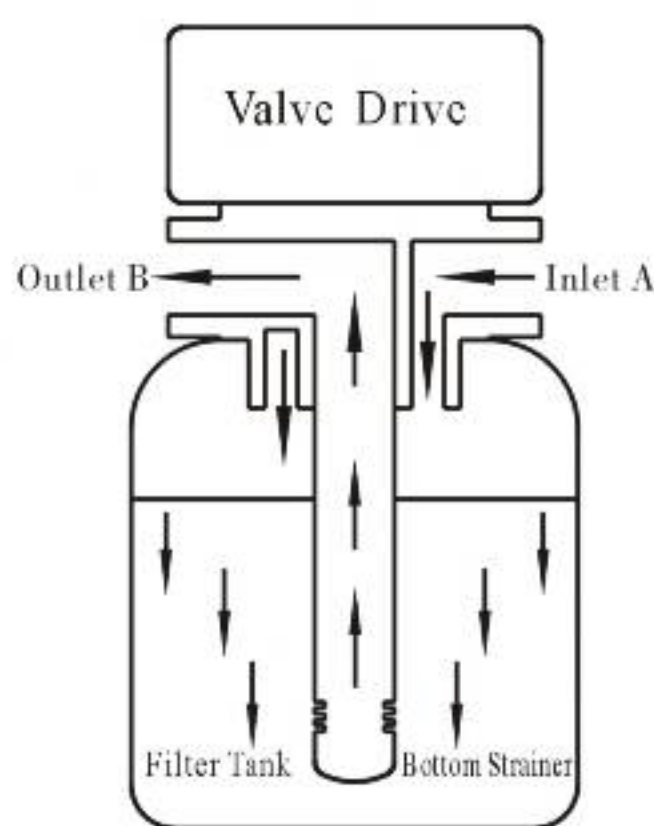

Raw water enter into control valve form inlet A, through valve body from the top of valve core, and going into tank from top ( or riser pipe outside of filter tank, the same as below ). Then, adown through filter materials to be purified water, then through bottom strainer to return to riser pipe, upward to valve body, pass through valve core, and finally flow out from outlet B.

### Backwash Position

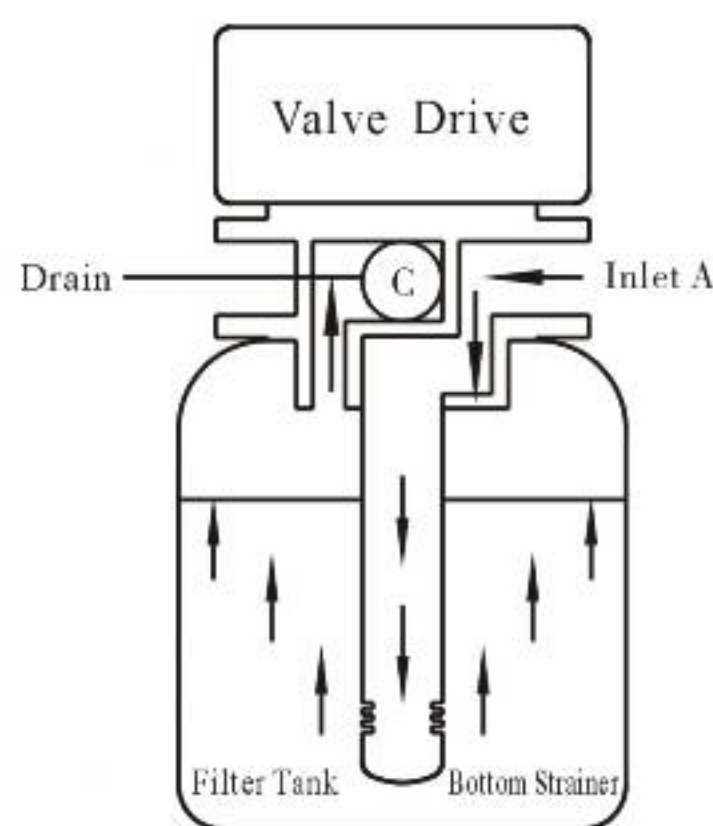

Raw water enter into control valve from inlet A, through valve body from the top of valve core, then from the bottom of tank (or riser pipe inside, the same as below), bottom strainer into tank, upward through filtering layers, and valve body, valve core, finally flow out from drain C.

### Fast Rinse Position

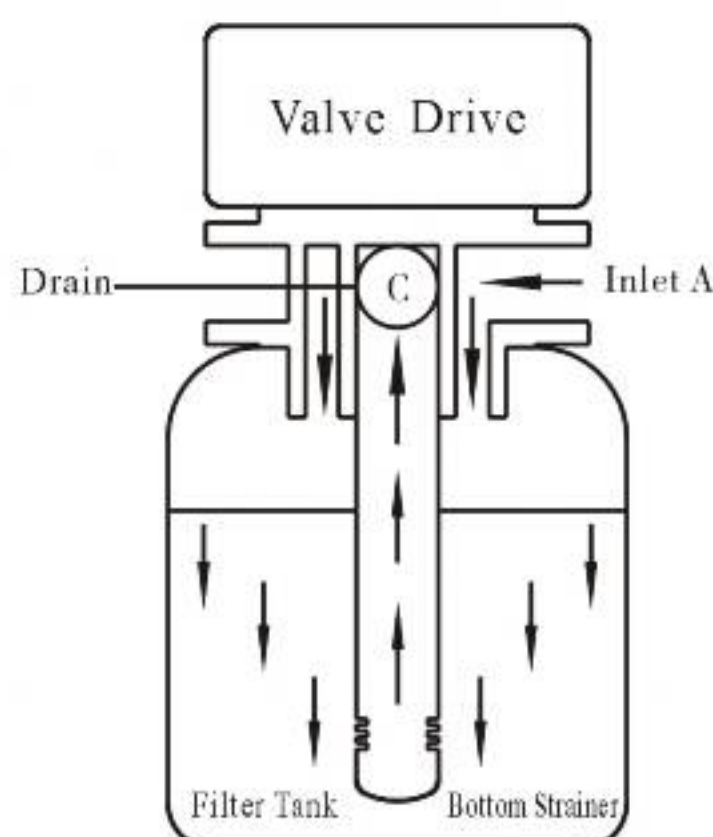

Raw water enter into control valve from A, through valve body from the top of valve core, and enter into tank from the top. Then, adown through the filtering layers, return to riser pipe from bottom strainer, upward to valve body, through valve core, finally flow out from drain C.



# Maintenance Guide

## Part of Control Valve

Problem	Cause	Correction
1. Filter can not wash	A. Device power off. B. Washing time set wrongly. C. Controller damaged.	A. Check supply power whether normal or not (including fuse, plug, switch etc). B. Reset time. C. Check or change controller.
2. Filter outputs original water	A. By pass ball valve opened. B. Indication plate at the '●' state. C. Riser Pipe leaked. D. Valve body leaked.	A. Close the by pass ball valve. B. Make manual hand valve leave the position of '●' suited for F67. C. Make sure riser pipe have not coll up, check base seal rings. D. Change valve body.
4. Water pressure damage	A. Pipeline leading to filter blocked by iron matter. B. Filter blocked by iron matter.	A. Clean up pipeline of filter. B. Clean up control valve. Add cleaning liquid to tank in order to increase the washing efficiency.
5. Filter flow out from drain pipe.	A. Air in systems. B. Backwash intensity is too big. C. Top strainer damaged.	A. Make sure exhaust normally in system. Check it whether dry or not. B. Decrease the backwash intensity. C. Change the top strainer.
6. Control valve continuously circulate	A. Signal line be cut off B. Fault on controller C. Wheel be blocked by abnormal things.	A. Insert the signal line again B. Change the controller C. Take out the abnormal things
7. Water continuously flow out from the drain	A. Valve body inside leaked B. Power off when backwash or fast rinse	A. Change valve body B. Switch by hand to service state F67 or close by pass valve reopen when power normal.

## Controller

1. All signs and figures light in screen.	A. The connect line between screen panel and control panel damaged. B. Main control panel damaged. C. Transformer get wet or damaged.	A. Change the connect line. B. Change the main control panel. C. Check or change the transformer.
2. No show in screen.	A. The connect line between screen panel and control panel damaged. B. Screen panel damaged. C. Main control panel damaged. D. Power cut off.	A. Change the connect line. B. Change the screen panel. C. Change the main control panel. D. Check the cables and main power.
3. Only E1 show in screen and flickering.	A. The connect line between locating panel and main control panel damaged. B. Locating panel damaged. C. Mechanical driving device damaged. D. Main control panel damaged. E. The connect line between driver and main control panel damaged. F. Driver damaged.	A. Change the connect line. B. Change the locating panel. C. Check the mechanical gearing. D. Change the main control panel. E. Change the connect line between driver and control panel. F. Change the driver.
4. Only E2 show in screen and flickering.	A. Hall components on locating panel damaged. B. The connect line between locating panel and main control panel damaged. C. Main control panel damaged.	A. Change the locating panel. B. Change the connect line. C. Change the main control panel.
5. Only E3 show in screen and flickering	A. The memory chip on main control panel damaged.	A. Change the main control panel.
6. Only E4 show in screen and flickering.	A. The time chip on main control panel damaged.	A. Change the main control panel.



# Guarantee Card

Dear Client:

This card is the guarantee credence of RUNXIN brand multi-functional flow control valve. It is kept by the client himself. You could get the after-sale services from the supplier which is appointed by RUNXIN manufacturer. Please keep it properly. It couldn't be retrieved if lost.

It couldn't be repaired free of charge under the below conditions:

- (i) Guarantee repair period expired.
- (ii) Damage resulting from using, maintenance, and keeping that are not according to the instruction.
- (iii) Damage resulting from repairing not by the appointed maintenance man.
- (iv) No purchase credence and effectual invoice.
- (v) Content in guarantee credence is unconfirmed with the label on the real good or be altered.
- (vi) Damage resulting from force majeure.

Product Name	Multi-functional Flow Control Valve for Water Treatment Systems		
Brand			
Model	TM.F	Code Of Valve Body	
Guarantee Term	One year	Notice: Charge the fee over expiration date	
Purchase Company Name		Tel Fax	
Problem		Date of Repairing	
Solution			
Date of Accomplishment		Signature by Maintenance Man	







---

**WENZHOU RUNXIN MANUFACTURING MACHINE CO.,LTD**

ADD: No.1,Longfang Ind.Zone, Nanjiao, Wenzhou, Zhejiang, ChinaP.C:325029

Tel: 86-577-88635628 88630038 Fax: 86-577-56848020-8003

Http://www.run-xin.com E-mail:runxin86@yahoo.com.cn